

Innenglied

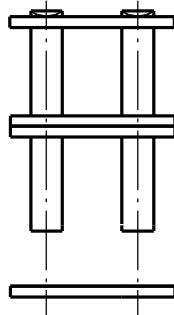
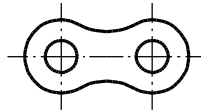

= Außenglied

Stiftbock

+ Außenlasche

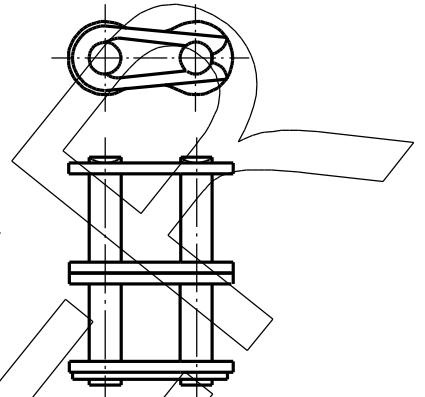

Verbindungsglied mit Feder

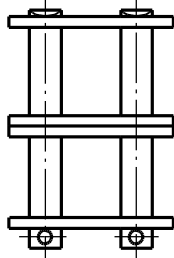
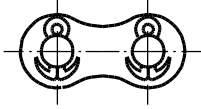

Verbindungsglied mit Splinten

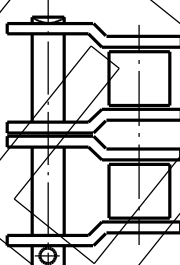
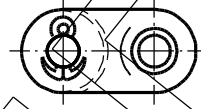

Gekröpftes Glied mit Splint

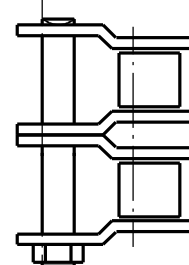
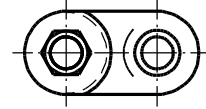

Gekröpftes Glied mit Mutter

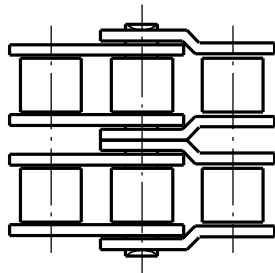
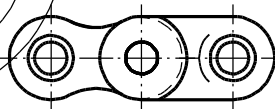

Gekröpftes Doppelglied



ROEDER KETTENTECHNIK

Allgemeintoleranzen  
DIN ISO 2768 T1 m  
DIN ISO 2768 T2 K

Maßstab 1:1

(Gewicht)

Datei: VSG\_DUPLEX.dcd

Datum

Name

Bearb. 06.09.04

Heinrichs

Gepr.

Norm

Verschlußglied Duplex

Zeich.-nr.: \_\_\_\_\_

Blatt

Blätter

Zust.	Änderung	Datum	Name	Urspr.

Ers. für:

Ers. durch:

I:\Zeichnungen\_Documente\_Kunde\Vorlagen\03 Baugruppen\VSG\_DUPLEX.dcd